

60A, 200V Low Forward Voltage Schottky Rectifiers

FEATURES

- Trench MOS schottky barrier rectifiers
- Low forward voltage drop
- High efficiency, low power loss
- High temperature soldering guaranteed:
 270°C/10 seconds for TO-220AB and ITO-220AB
 260°C/10 seconds for TO-263AB
- RoHS compliant

TO-220AB

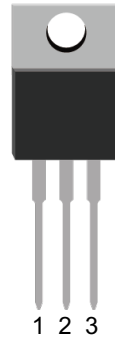

ITO-220AB

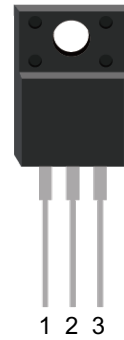

RoHS
COMPLIANT

HALOGEN
FREE
AVAILABLE

TO-263AB

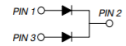
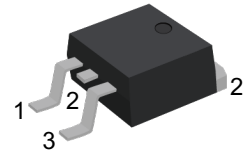

MECHANICAL DATA

- Case: TO-220AB, ITO-220AB, TO-263AB
- Case material: molding compound meets UL 94V-0 flammability rating
- Polarity: as marked on case body

P/N	Package
ST60200CT	TO-220AB
ST60200FCT	ITO-220AB
ST60200TA	TO-263AB

TYPICAL APPLICATION

General purpose use in AC to DC bridge full wave rectification for SMPS, lighting, adapter, charger, home appliance, office equipment and telecommunication.

MAXIMUM RATINGS

T_A=25°C unless otherwise noted

Parameter	Symbol	Value	Unit
Repetitive Peak Reverse Voltage	V _{RRM}	200	V
Average Forward Rectified Current	I _{F(AV)}	60	A
Peak Forward Surge Current (8.3 ms single half sine-wave superimposed on rated load)	I _{FSM}	320	A
Operating Junction Temperature Range	T _J	-55 to +150	°C
Storage Temperature Range	T _{STG}	-55 to +150	°C

ELECTRICAL CHARACTERISTICS

T_A=25°C unless otherwise noted

Parameter	Test Conditions	Symbol	Value		Unit
			Typ.	Max.	
Forward Voltage@I _F =30A	T _A =25°C	V _F	1.0	1.2	V
	T _A =125°C		0.9	1.1	
Reverse Current @V _{RRM}	T _A =25°C	I _R	10	50	uA
	T _A =125°C		5	35	mA
Typical Thermal Resistance TO-220AB, TO-263AB ITO-220AB		R _{θJC}	2		°C/W
			4		

60A, 200V Low Forward Voltage Schottky Rectifiers

RATINGS AND CHARACTERISTIC CURVES

$T_A=25^\circ\text{C}$ unless otherwise noted

FIG.1: Forward Output Current Derating Curve

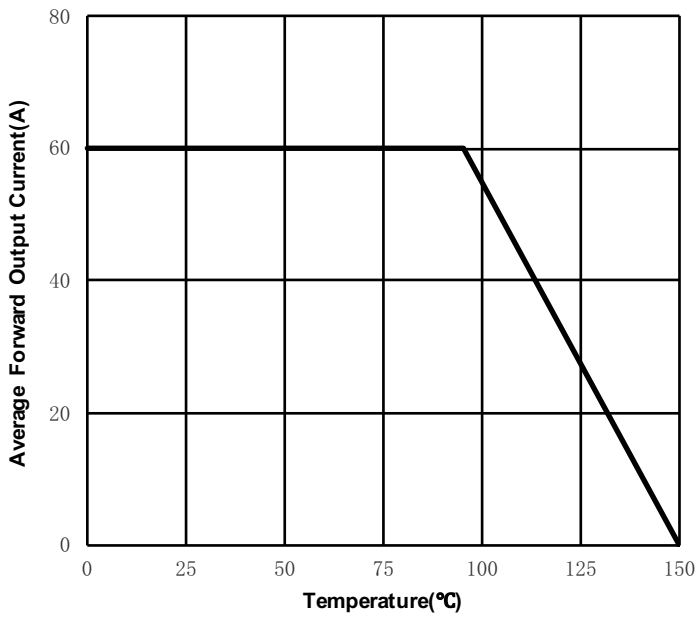

FIG.2: Maximum Non-Repetitive Peak Forward Surge Current

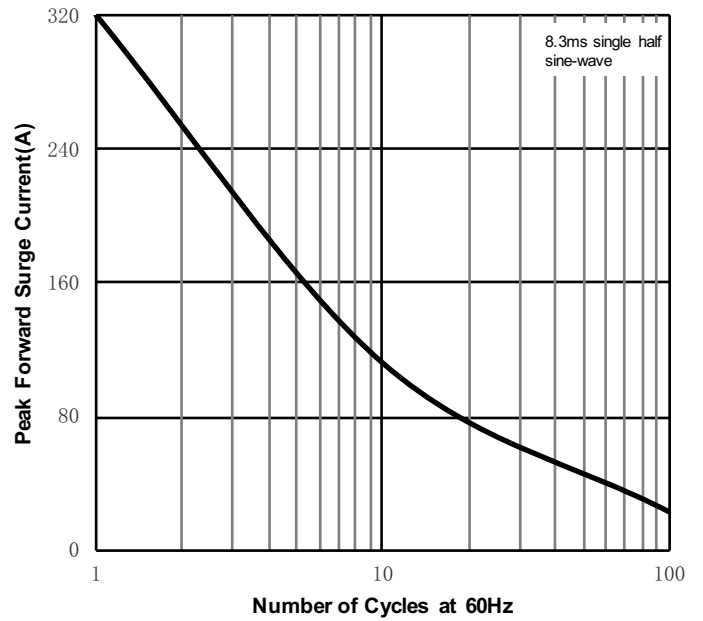

FIG.3: Typical Forward Characteristics

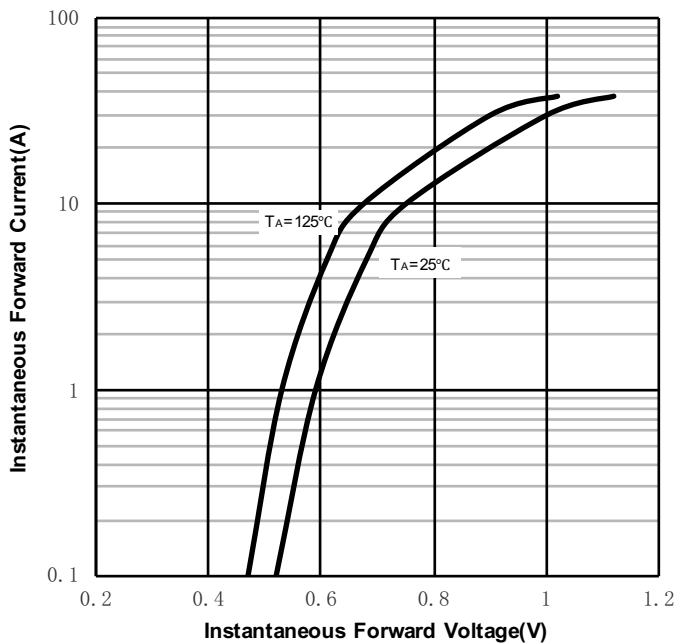
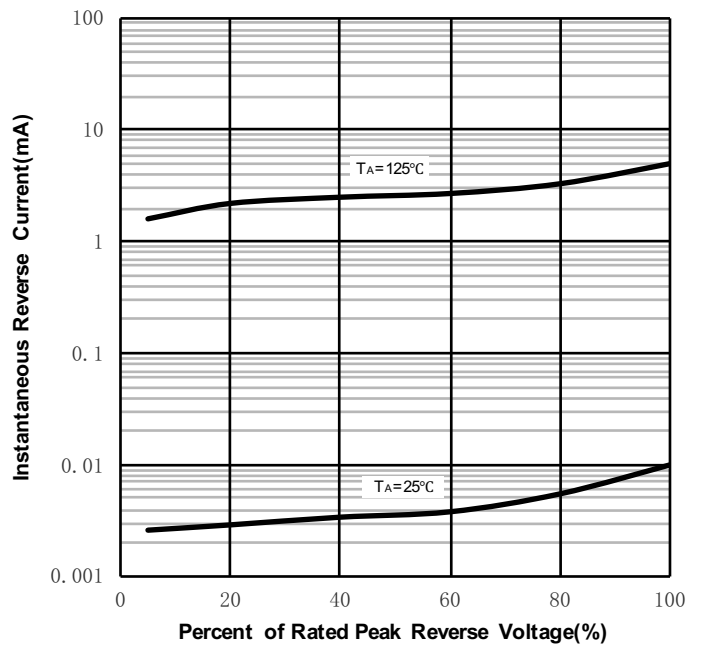

FIG.4: Typical Reverse Characteristics



60A, 200V Low Forward Voltage Schottky Rectifiers

PACKAGE OUTLINE DIMENSIONS

TO-220AB

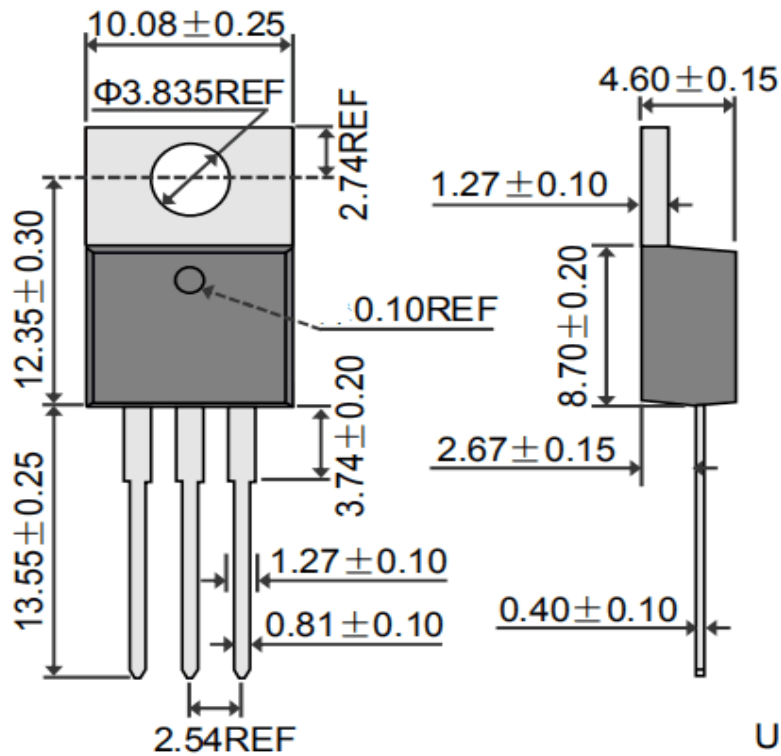

Unit:mm

ITO-220AB

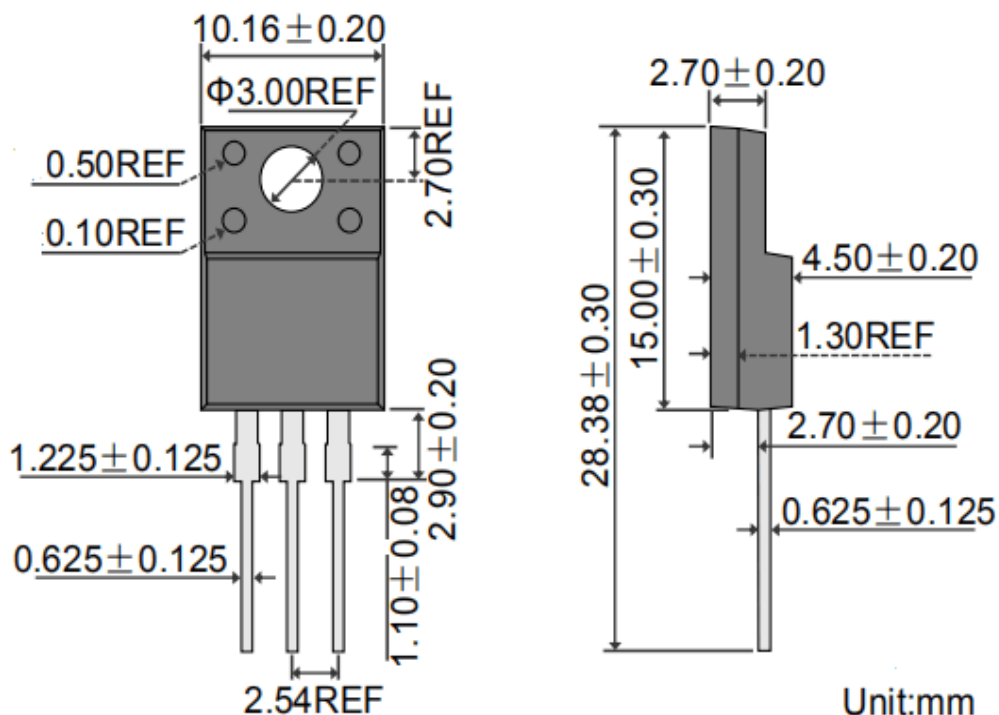

Unit:mm

60A, 200V Low Forward Voltage Schottky Rectifiers

PACKAGE OUTLINE DIMENSIONS

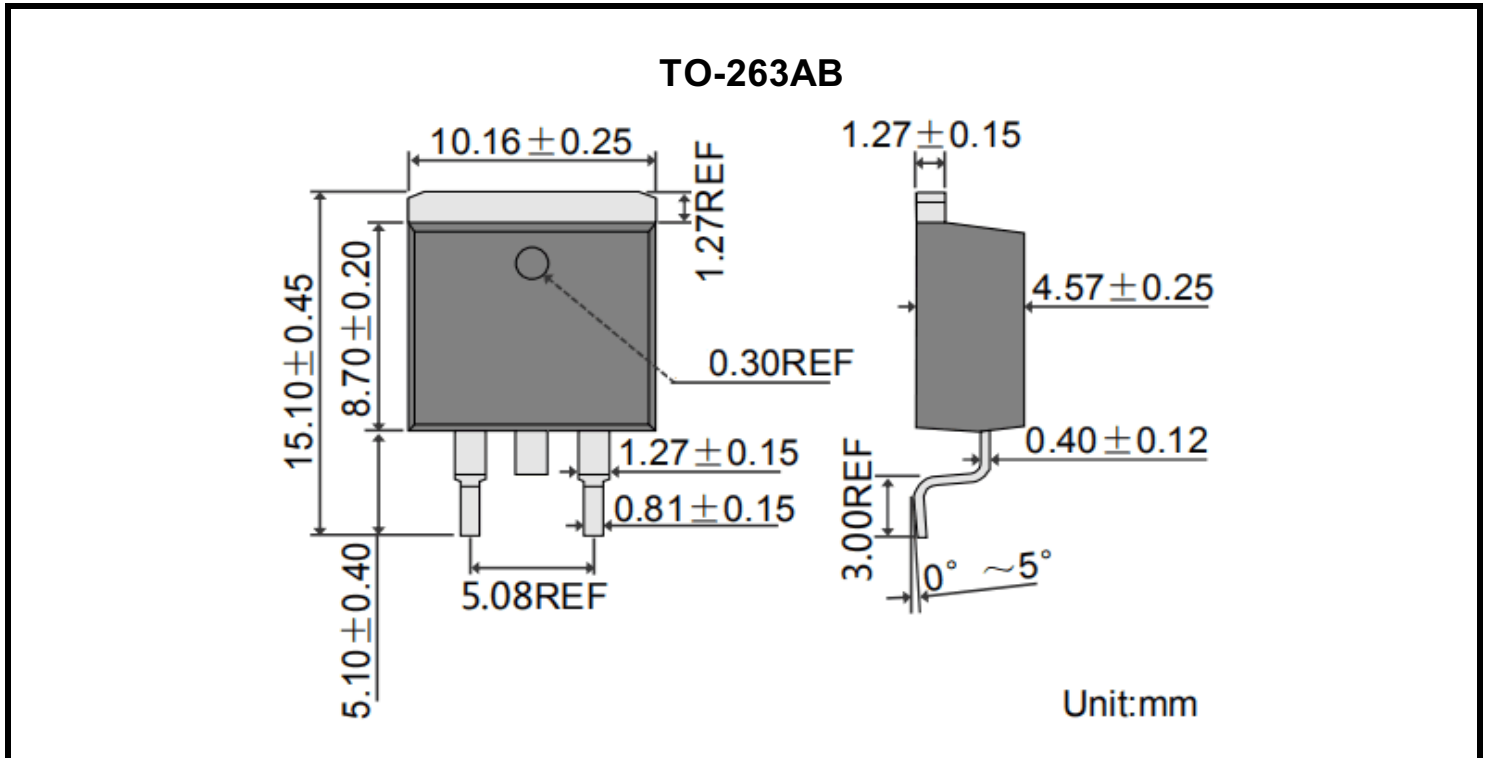

PACKING INFORMATION

Package	Tube(PCS)	Inner Box(PCS)	Carton(PCS)
TO-220AB	50	1,000	5,000
ITO-220AB	50	1,000	5,000
TO-263AB	50	1,000	5,000